

We devote all our knowledge
to serve people, enabling them
to lead long and healthy lives.

5 YEARS WITH CHEMAXON

Dancsó András

22 May 2019, ChemAxon UGM Budapest



A complex database

Chemical database technology:



Integration:



Programmers:

Pöcze Gábor
Uhrin Tamás
Vikár András
Peltz Csaba
Cseh Zoltán
Nyári Tibor

...

200 users:



ChemAxon components

- JChem
- Marvin
- Marvin JS
- Standardizer
- Partitioning Plugin
- Structure to Name

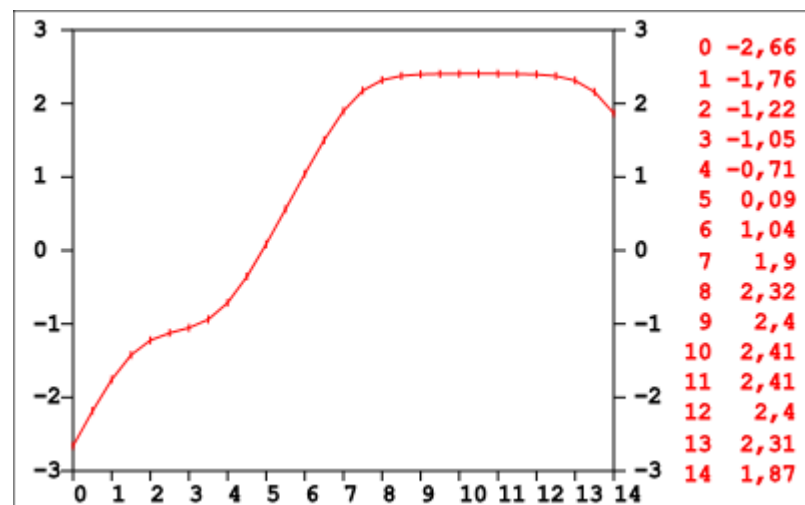
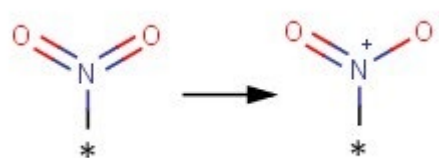

Structure to Name

- Automatic name generation following registration or modification
- Successful in 99.8 %
- Exceptions: some rather complicated complexes, where even Reaxys didn't give a correct systematic name

Database structure

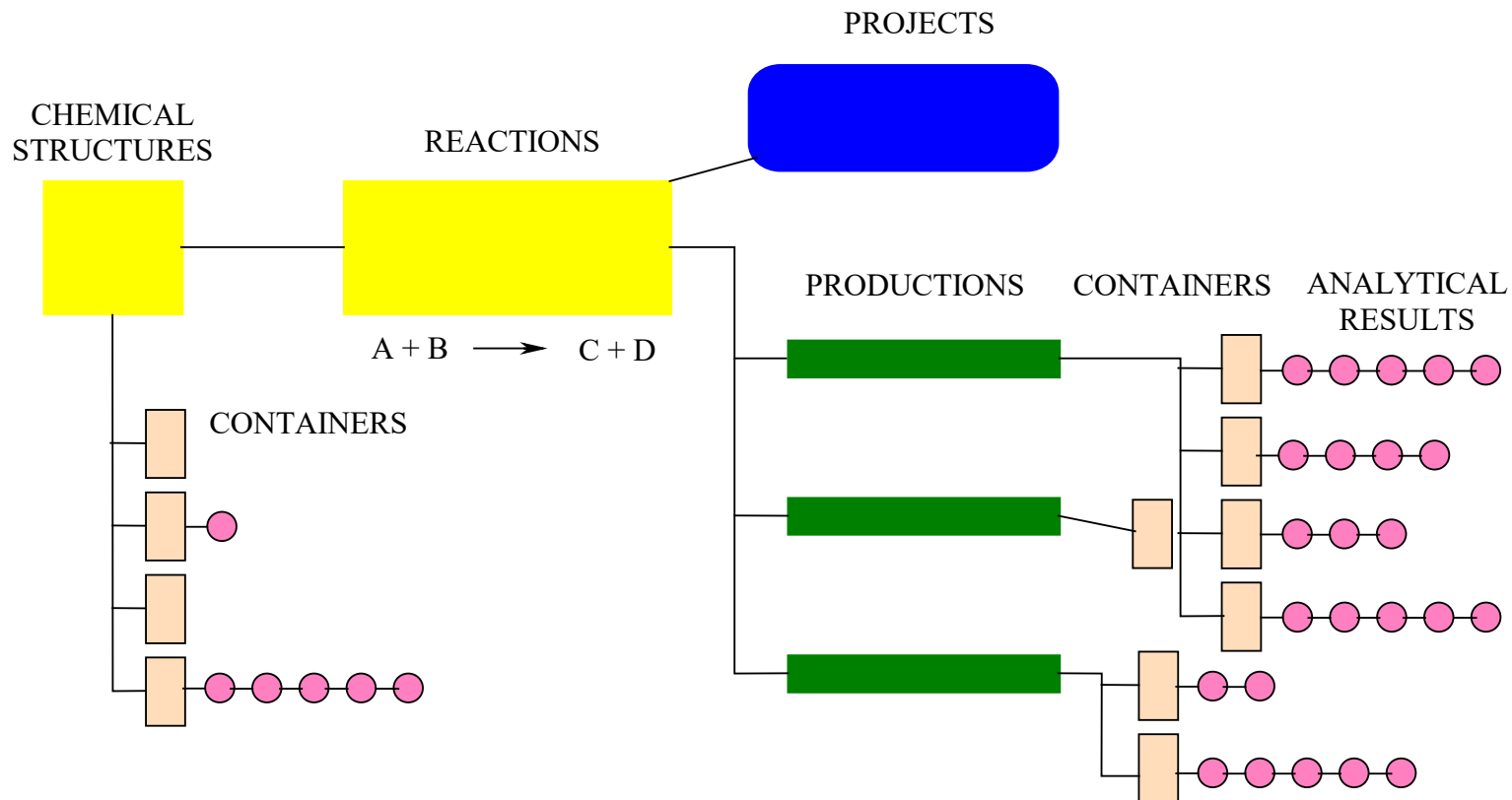

Logistics and ELN

Reagent containers:

- Unique barcode
- Location: building, room, cupboard, shelf, row
- Continuously tracked quantities

Safety:

- H and P phrases
- GHS symbols
- Label printing
- MSDS
- Controlled substances



§ Compliance Checker



Procurement:

- Starting and tracking orders

ELN functionality:

- Tracking of starting materials
- Physical constants
- Analytics
- Bilingual: English, Hungarian
- Hard copies

Stereochemistry

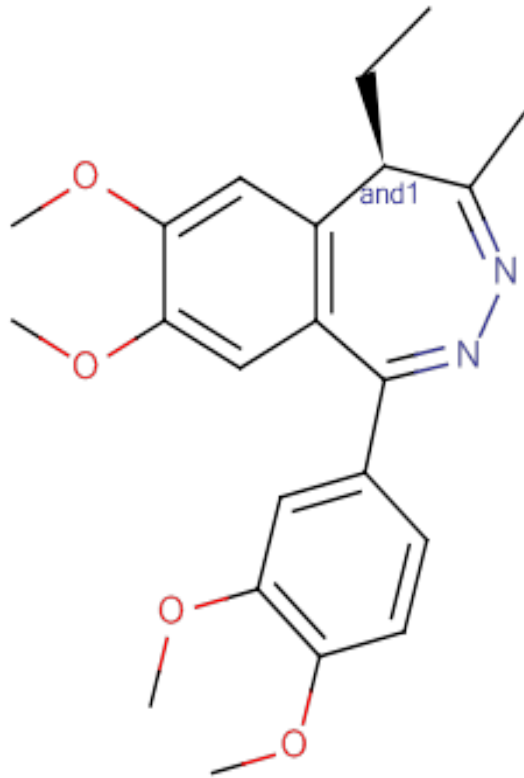

RACEMIC

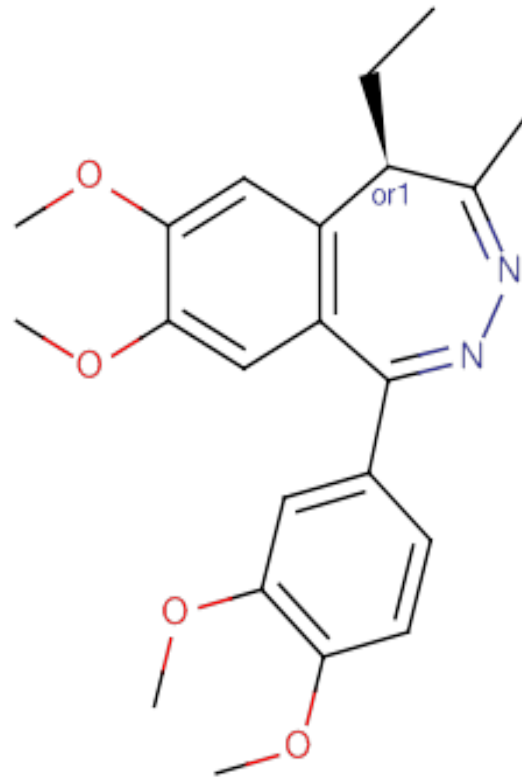

RESOLVED1

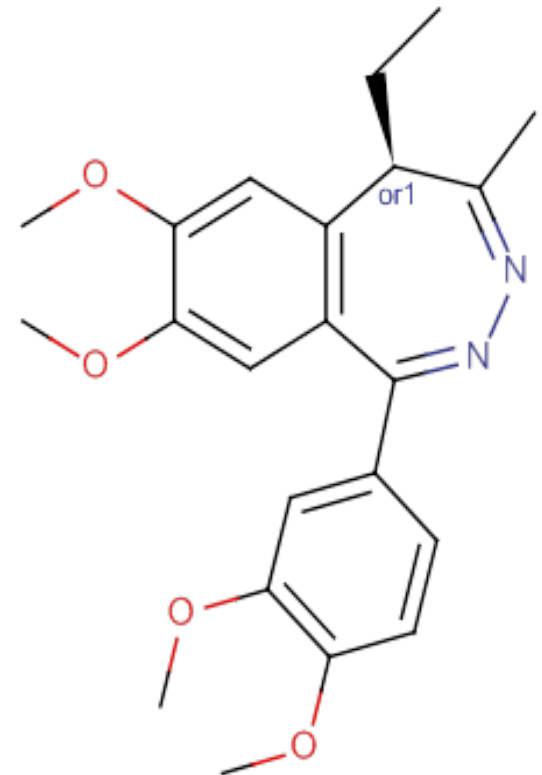

RESOLVED2

Example: tofisopam, an originality from Egis

Synthesis schemes: basic types

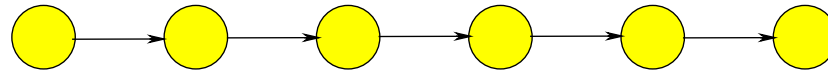

Linear

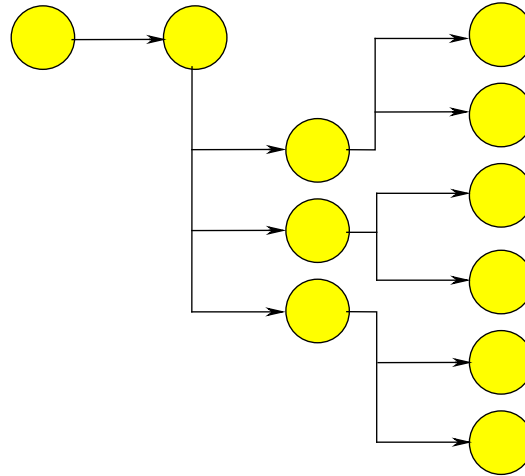

Combinatoric

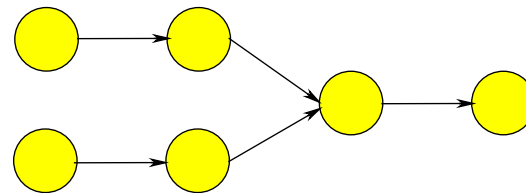

Convergent (Y)

Synthesis schemes: a real one

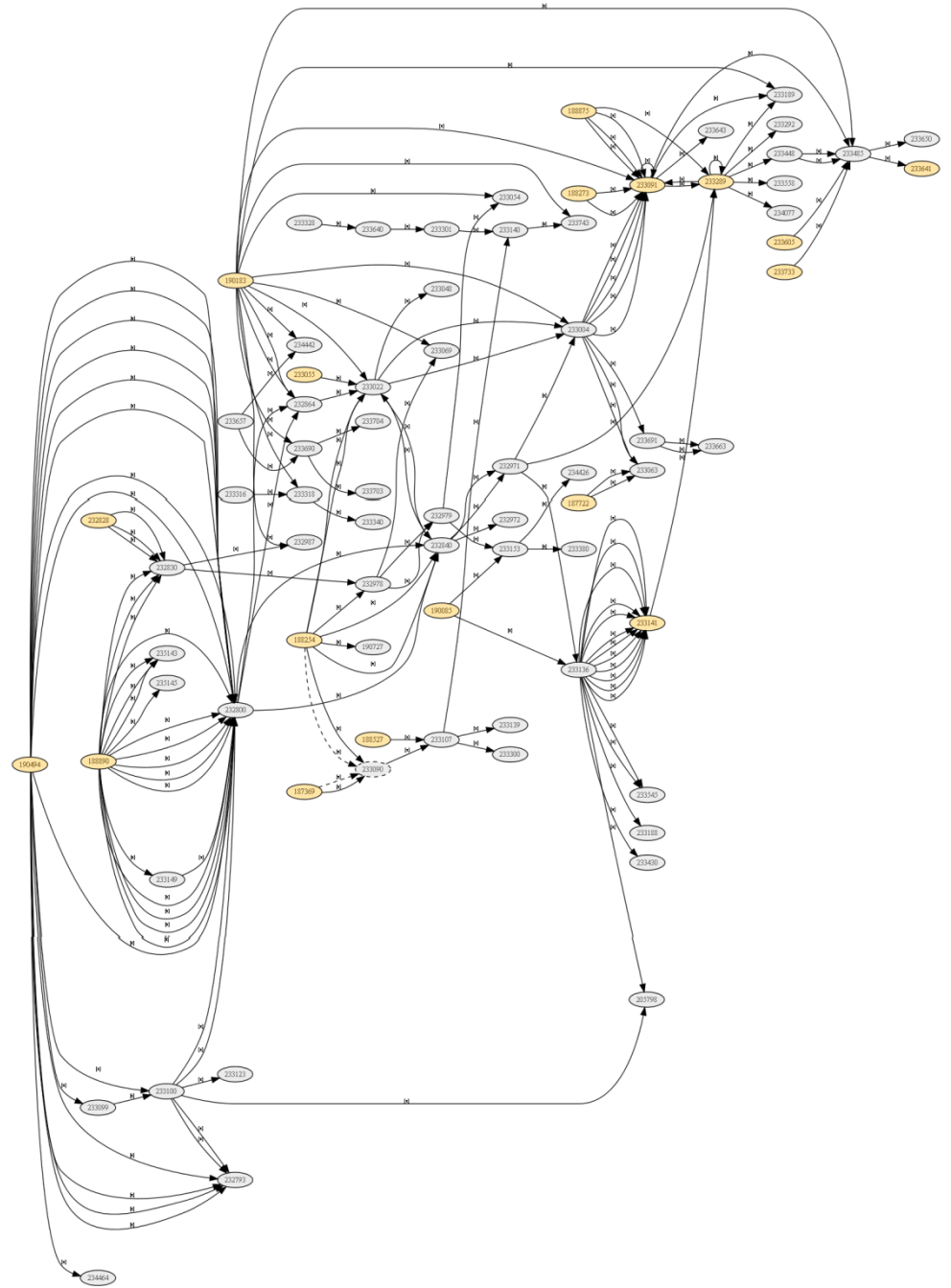

Assignment database

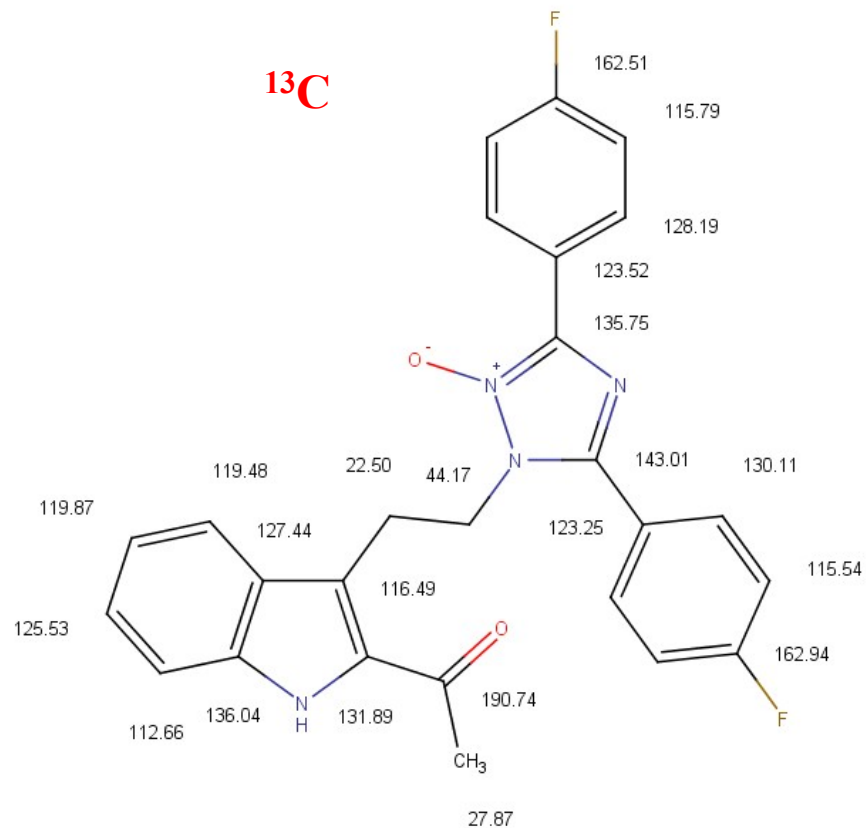
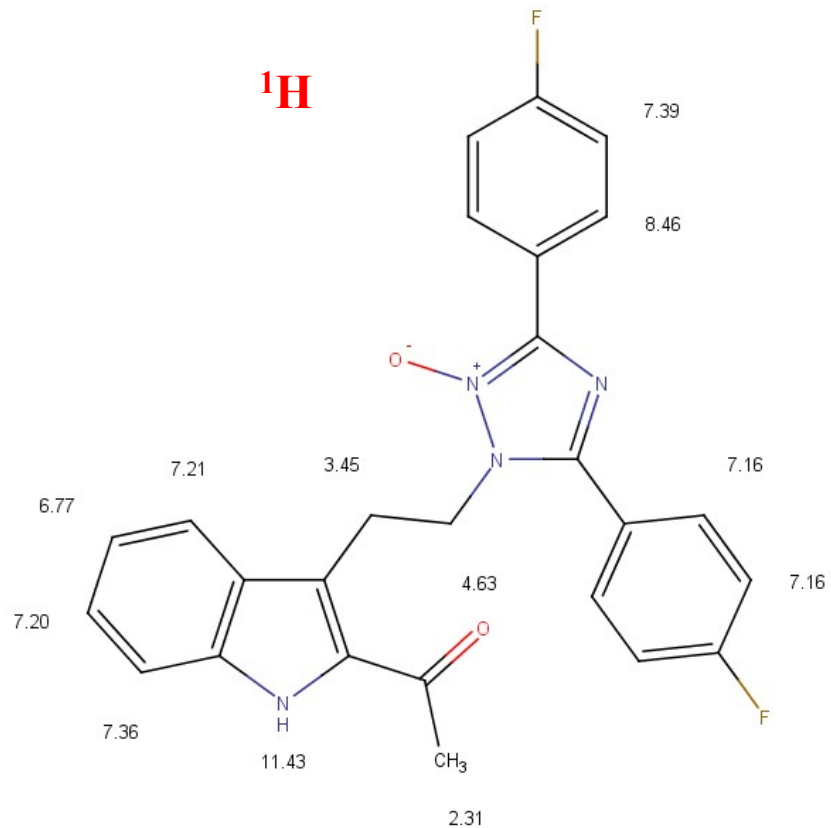

Milen, Matyas; Abranyi-Balogh, Peter; Dancso, Andras; Simig, Gyula; Keglevich, Gyorgy:

Reaction of 3,4-dihydro- β -carboline with 4-fluorophenyl-nitrile oxide, *Letters in Organic Chemistry*, **2010**, 7(5), 377-382.

Special thanks to

Chemistry project leaders:

Dr. Volk Balázs
Dr. Nagy Tamás

IT project leaders:

Hofbauer Sándor
Vágó László
Nagy Szabolcs



Administration:

Simonyi Dalma

IT support:

Rétsági Péter
Kovács Róbert

200 users



Thank you for your attention!

